

Operating Instructions

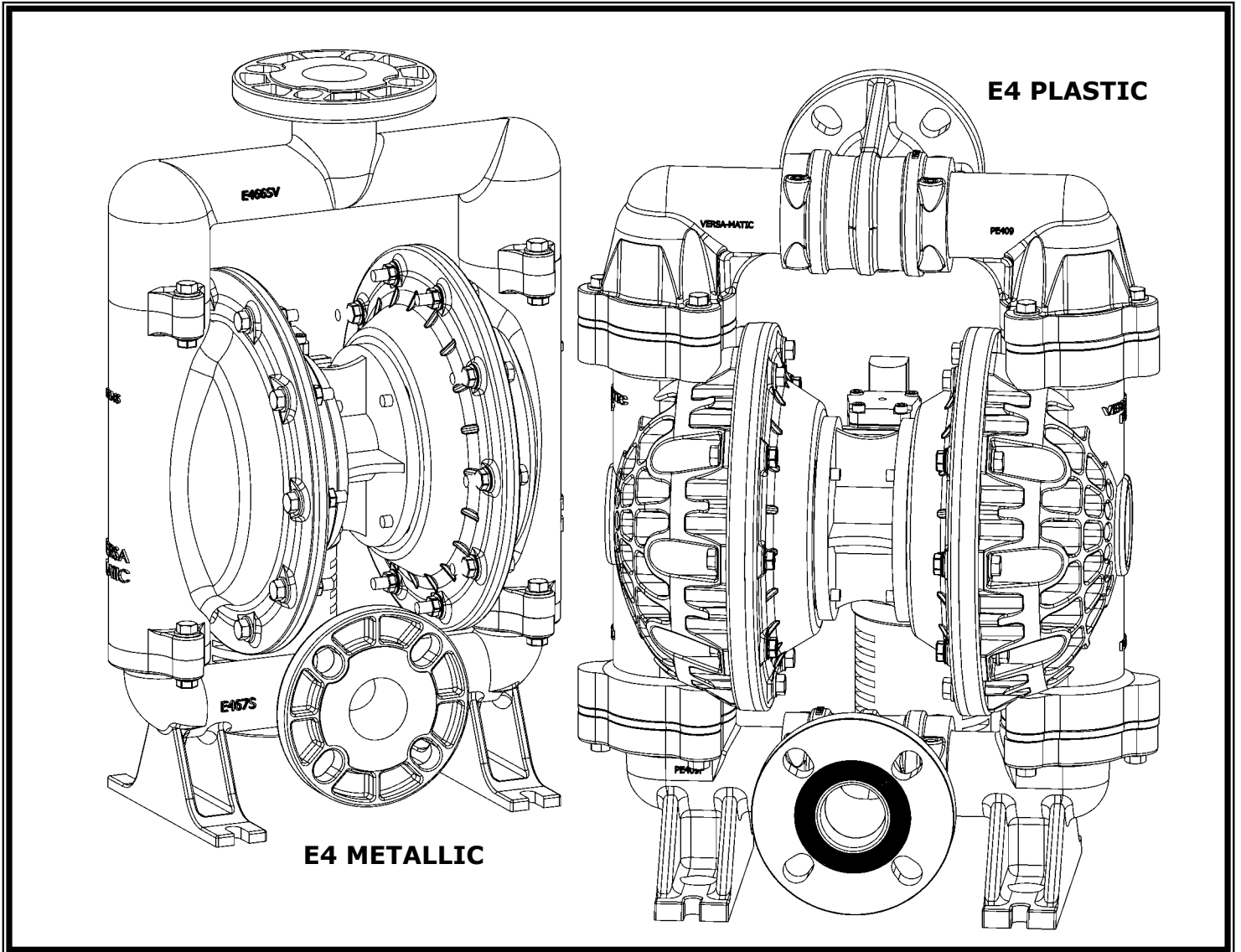

OI-E4-P/K/S/H, 9/05

E4 Elima-Matic Bolted Pumps

MODELS:
E4P
E4K
E4S
E4H

Specifications and Performance

Versa-Matic Pump Company		
Model E4 Elima-Matic Bolted Series		
	Metric	US
Flow Rate Adjustable to	0-275 lpm	0-72 gpm
Inlet/Discharge	40mm DIN	1-1/2" 150#
Air Inlet	1/2" FNPT	
Air Exhaust	3/4" FNPT	
Suction Lift, Dry	4.57 m	15 ft
Suction Lift, Wet	7.62 m	25 ft
Teflon, Dry	3.05 m	10 ft
Teflon, Wet	6.09 m	20 ft
MAX Particle Dia	4.78 mm	.188 in
SHIPPING WEIGHTS		
Plastic	14.5 kg	32 lbs
Metallic	29.5 kg	65 lbs
CAUTION: Do not exceed 8.5 bar (125 psig) air supply or liquid pressure.		

How To Read Pump Performance Curves

(See attached pump flow curves)

There are two graphs provided for each pump configuration. The first graph relates flow and air inlet pressure to discharge pressure. The second graph determines the required volume of air to run the pump at the desired flow rate.

The discharge pressure can be determined by locating the intersection between the desired flow rate and air inlet pressure curve on the appropriate discharge pressure graph.

The required air volume can be determined by locating the intersection between the desired flow rate and air inlet pressure curve on the appropriate air consumption graph.

The attached flow curves have been generated from actual flow meter tests. These tests are performed in a lab environment, pumping water at 21°C (70° F). Actual flow rates will be affected by pipe layout, fluid temperature, fluid viscosity, air volume and other factors beyond the control of Versa-Matic Pump Company.

40mm DIN FLANGE
1-1/2" 150# FLANGE
INLET & DISCHARGE

1/2" FNPT
air inlet

.437 WIDE SLOT

DIMENSIONS MODEL E4 POLYPROPYLENE / KYNAR		
ITEM	METRIC (mm)	INCH
A	400	15.75
B	319	12.56
C	479	18.85
D	548	21.58
E	175	6.90
F	135	5.30
G	82	3.22
H	236	9.31
J	203	8.00
K	178	7.00
L	121	4.75

DIMENSIONS MODEL E4 STAINLESS / HASTELLOY		
ITEM	METRIC (mm)	INCH
A	335	13.20
B	319	12.56
C	442	17.41
D	512	20.16
E	175	6.90
F	135	5.30
G	80	3.13
H	223	8.78
J	178	7.00
K	152	6.00
L	70	2.76

* Both the Metallic and Plastic models can be assembled with either horizontal or vertical discharge manifold configurations. (The illustrations depicts a plastic pump in a horizontal discharge position)

- Teflon is a registered trademark of E.I.DuPont
 - Kynar is a registered trademark of Penwalt Corp.

E4P Rubber Fitted Pump

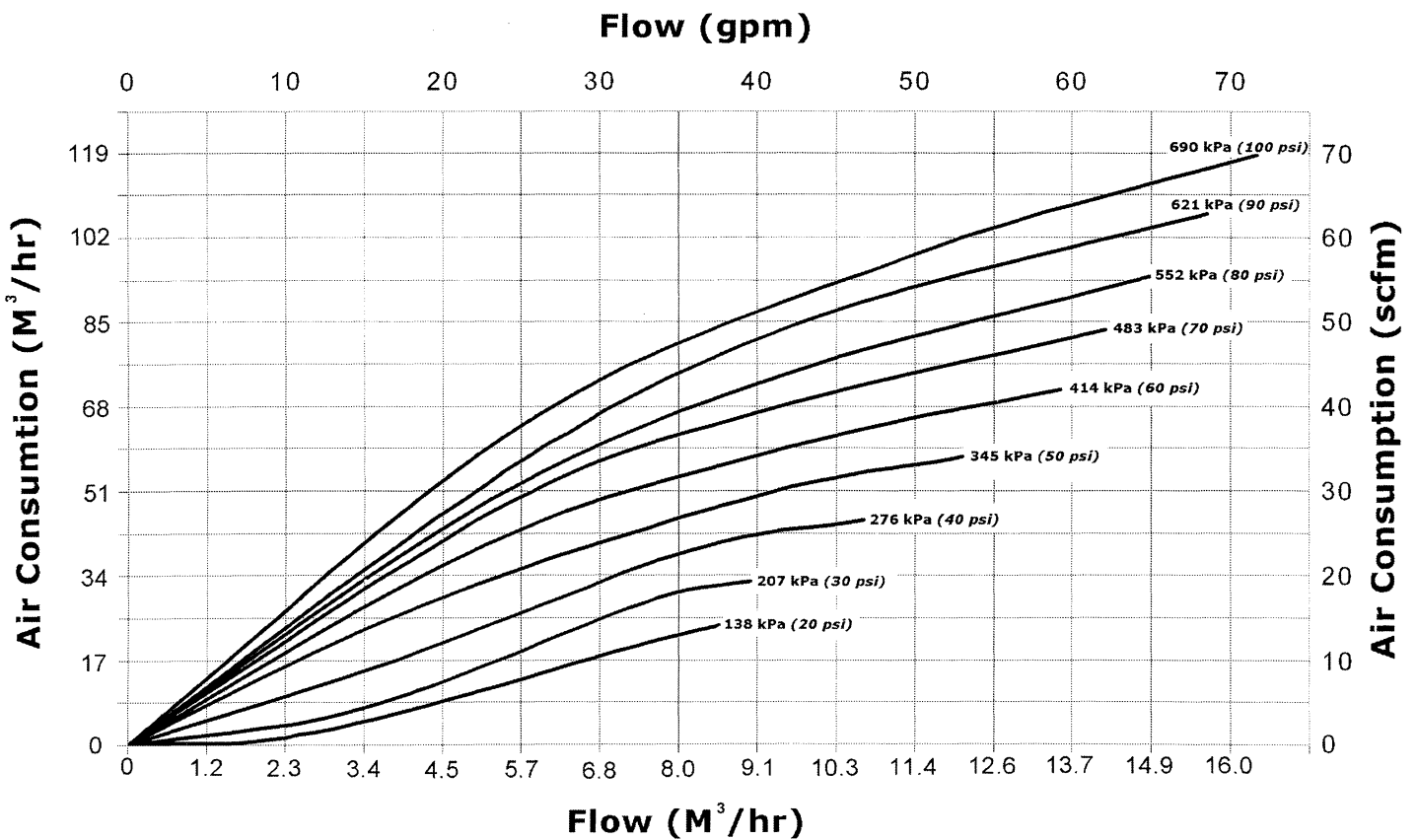
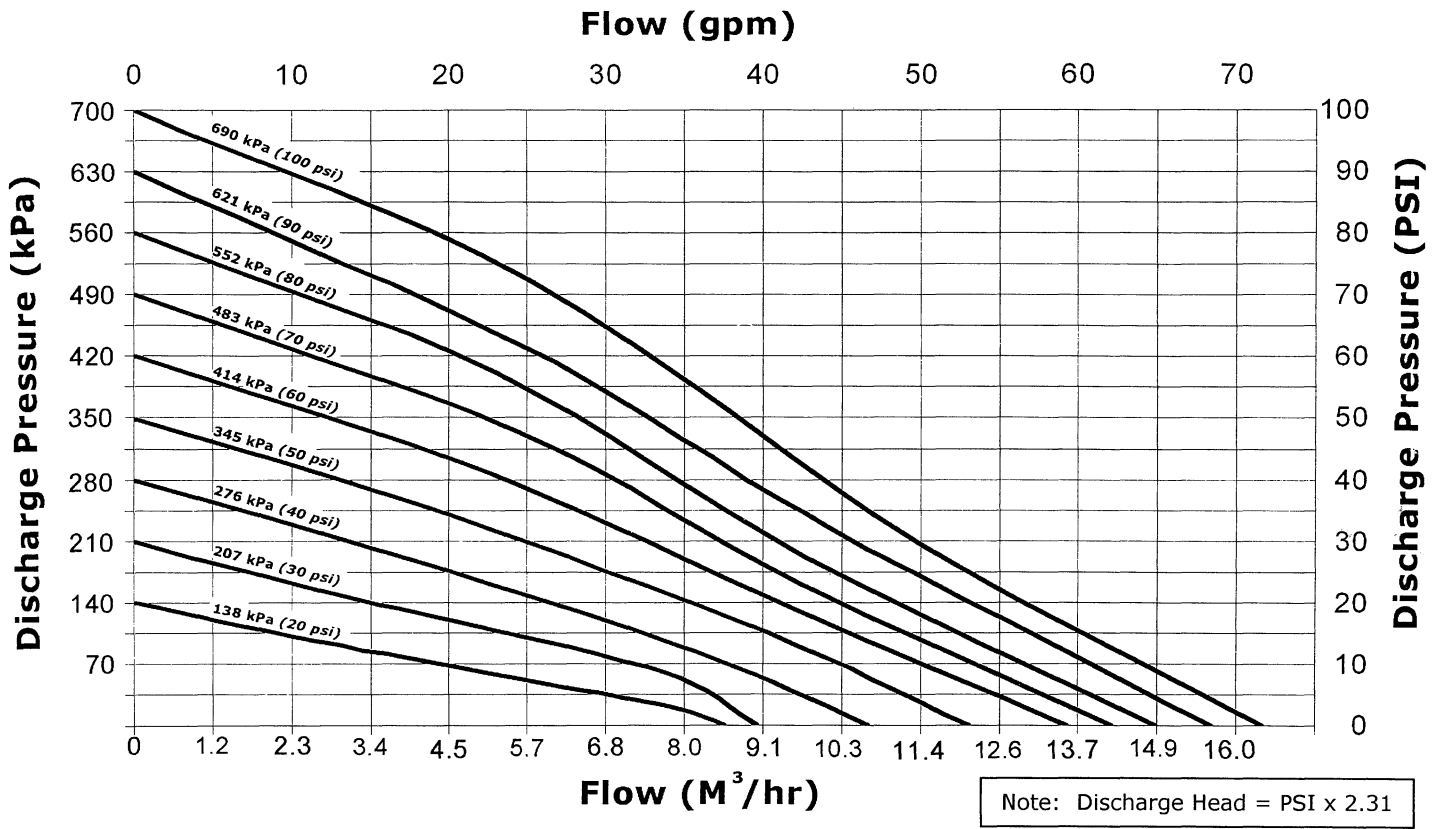

E4P Teflon Fitted Pump

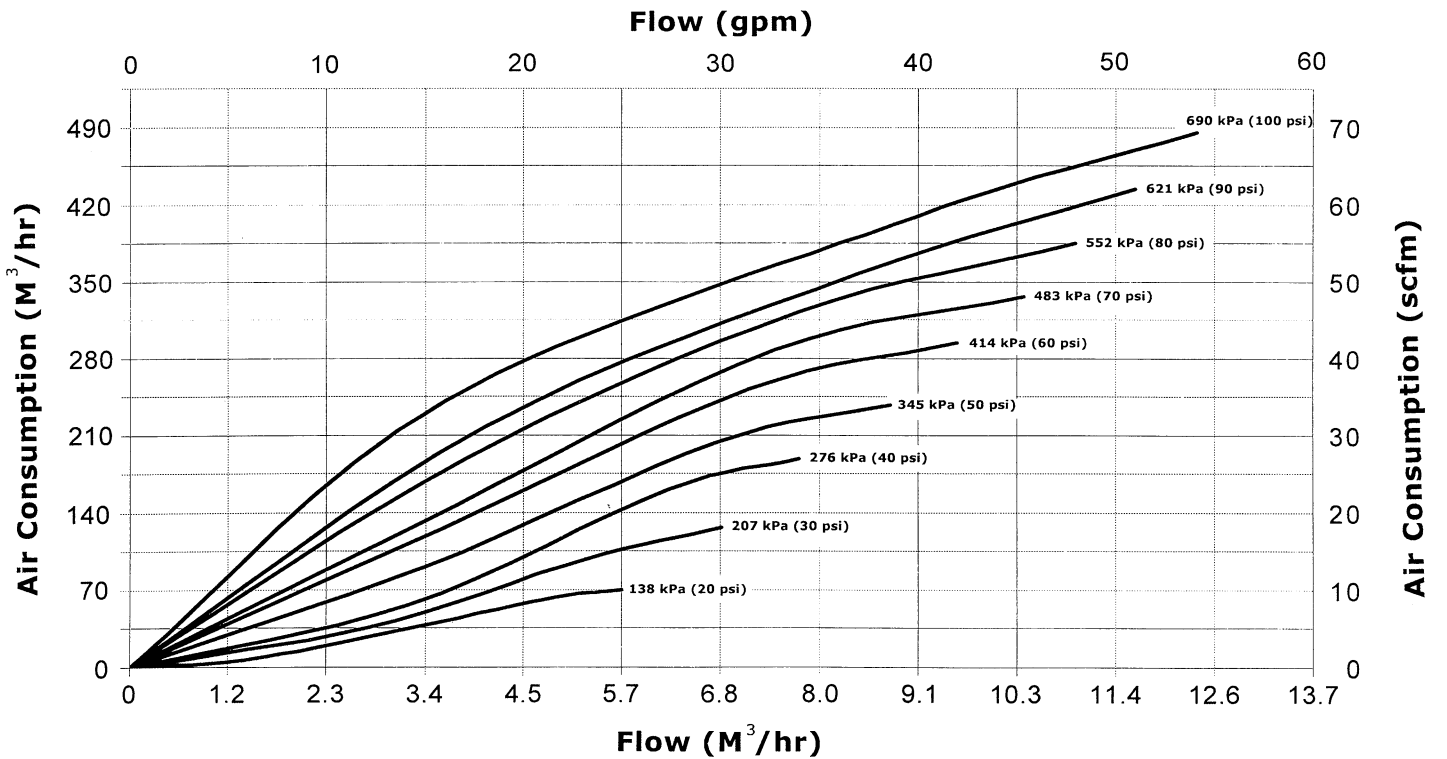
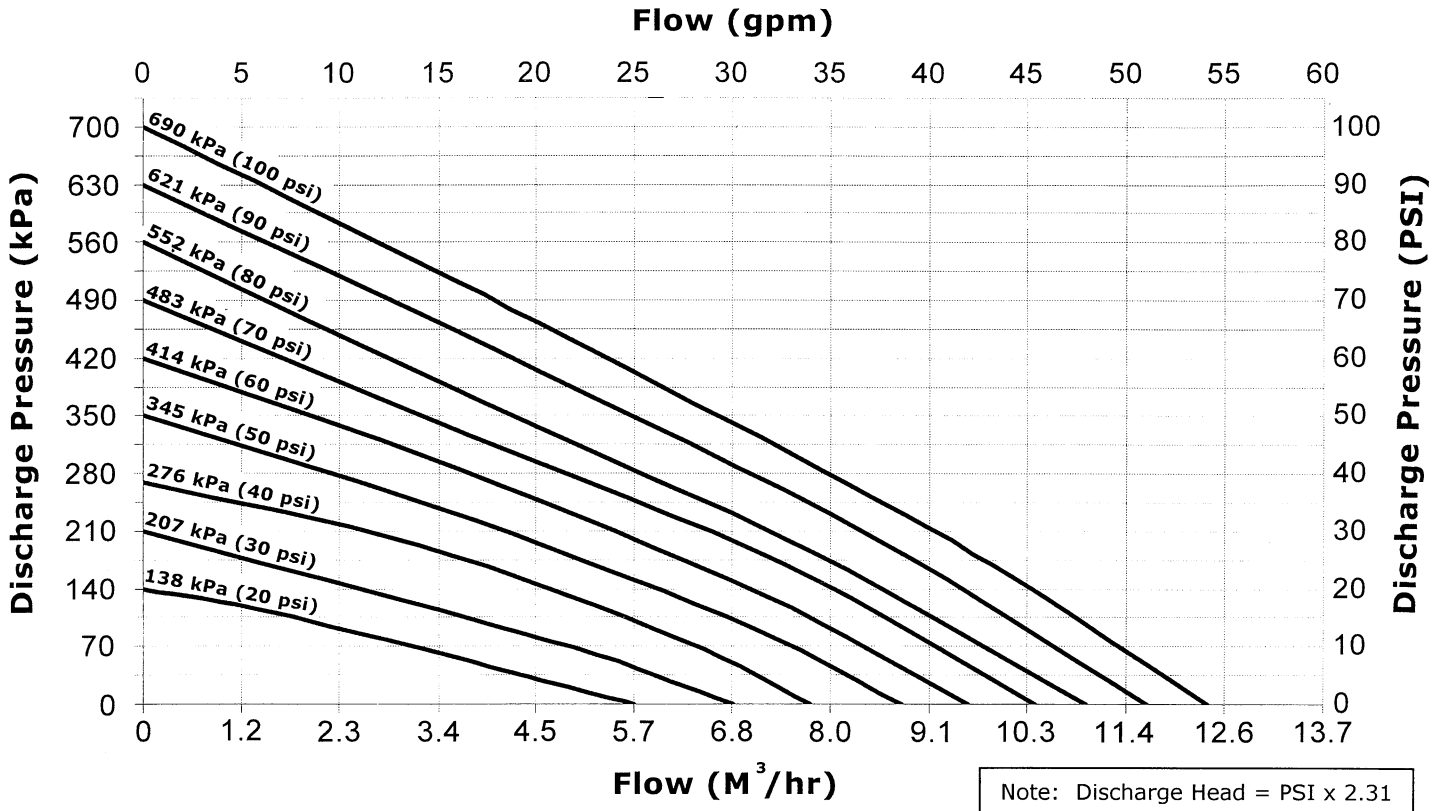

E4S Rubber Fitted Pump

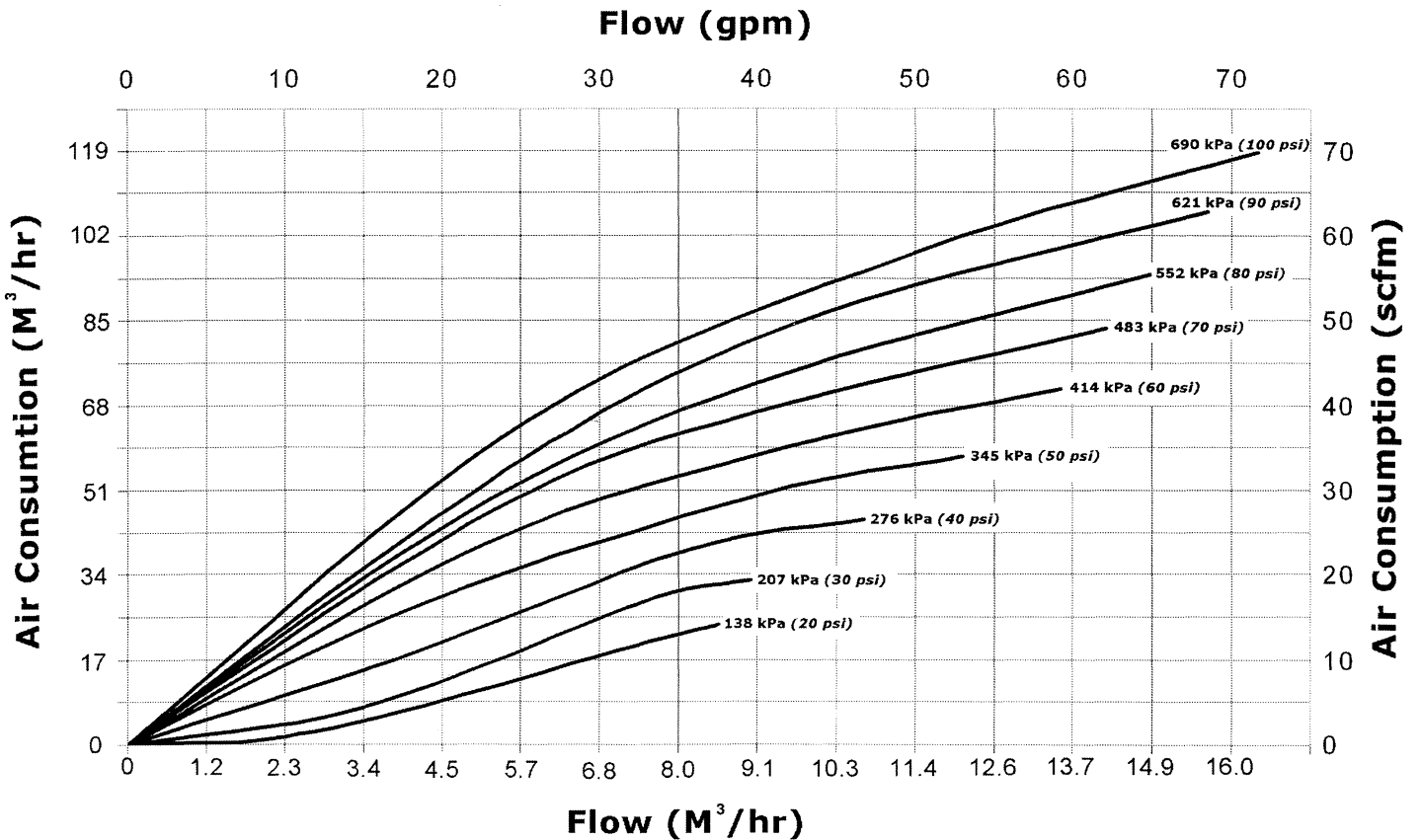
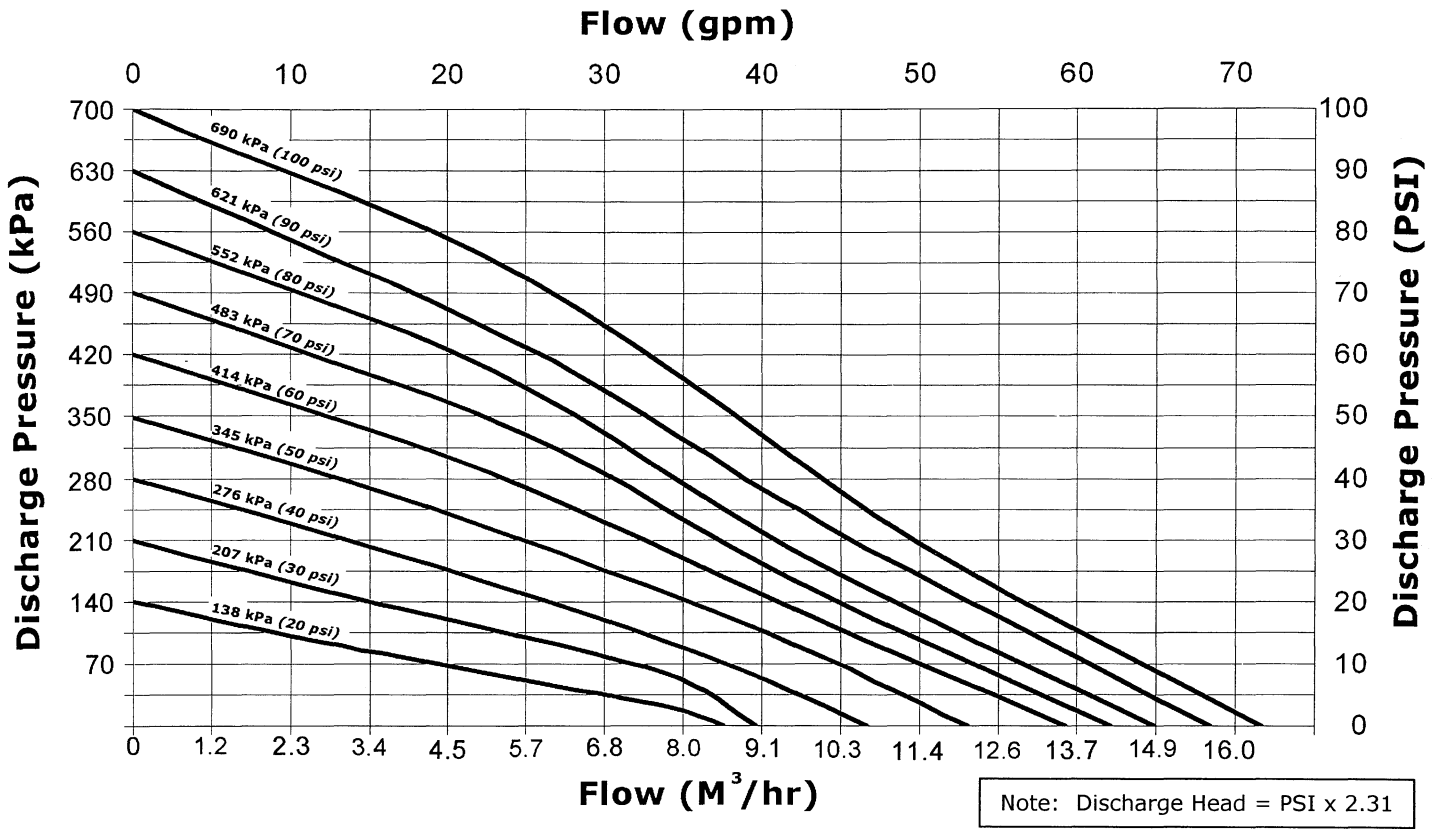

E4S Teflon Fitted Pump

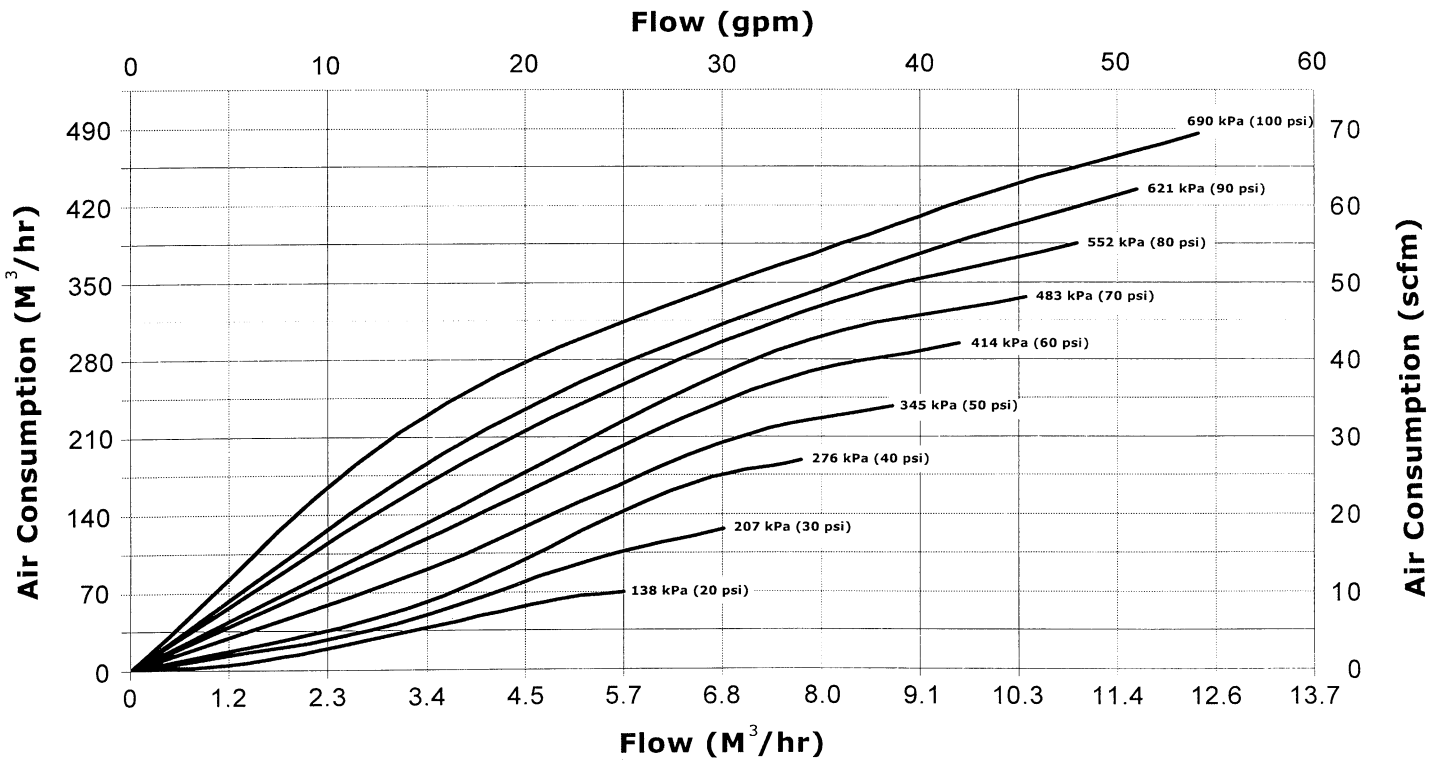
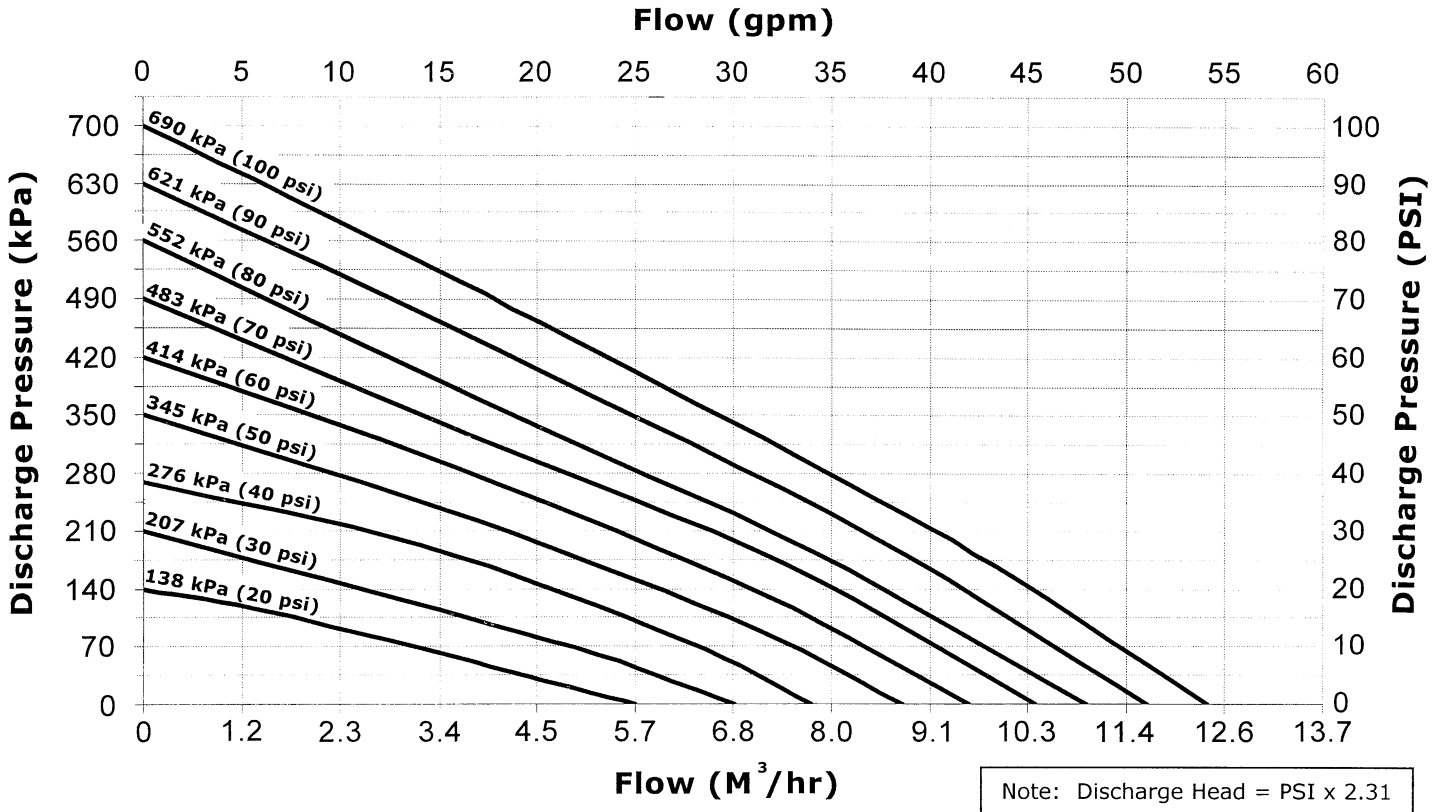

Installation

The E4 pump comes with a footed base for easy mounting in permanent installations. The pump should be mounted in a vertical position. In permanent installations, the pump should be attached to plant piping using a flexible coupling on both the intake and the discharge connections to reduce vibration to the pump and piping. To further reduce vibration, a surge suppresser next to the pump may be used.

Suction pipe size should be at least 1-1/2 inches in diameter or even larger if highly viscous fluid is to be pumped. If suction hose is used, it must be of a non-collapsible reinforced type. Discharge piping should be of at least 1-1/2 inches. It is critical, especially on the suction side of the pump, that all fittings and connections are airtight or pumping efficiency will be reduced and priming will be difficult.

The air supply line should be at least 1/2 inch in diameter. Make certain the supply line and compressor are capable of supplying the required pressure and volume of air needed to operate the pump at the desired flow rate. The quality of the compressed air source should be considered. Air that is contaminated with moisture and dirt may result in erratic pump performance and increased maintenance cost as well as frequent process "down time" when the pump fails to operate properly.

Pump Operation

The pump is powered by compressed air. Compressed air is directed to the pump air chamber by the main air valve. The compressed air is separated from the fluid by a membrane called a diaphragm. The diaphragm in turn applies pressure on the fluid and forces it out of the pump discharge. While this is occurring, the opposite air chamber is de-pressurized and exhausted to atmosphere and fluid is drawn into the pump suction. The cycle again repeats, thus creating a constant reciprocating action, which maintains flow through the pump. The flow is always in through the bottom suction connection and out through the top discharge connection. Since the air pressure acts directly on the diaphragms, the pressure applied to the fluid roughly approximates the air supply pressure supplied to the main valve.

Troubleshooting

The pump will not run, or runs slowly:

1. Examine the air inlet screen for debris.
2. Check for a sticking air valve. Remove the air valve from the pump and flush with solvent to remove dirt and/or debris. Check the spool and sleeve for nicks and scratches. If the spool is shiny instead of dull black, the spool and sleeve may be worn out and may need to be replaced. Clean all ports and airways and replace worn out gaskets and o-rings.
3. Check pilot shaft and main shaft for scoring and scratches; replace if needed. Replace the pilot shaft and main shaft o-rings if they are worn, flat or torn.

The pump runs, but little or no material flows:

1. Check for pump cavitation, slow the pump speed down to match the thickness of the material being pumped.
2. Look for sticking ball checks. If the material being pumped is not compatible with the ball material, the elastomer may swell. Replace the balls and seats with a compatible elastomer type.
3. Make sure all the suction line fittings and connections are tight.

Air bubbles in pump discharge:

1. Look for a ruptured diaphragm.
2. Check for suction leaks in pump manifolds and piping.

Material comes out of the pump air exhaust:

1. Inspect the diaphragm for rupture.
2. Check the tightness of the diaphragm plates to the pump shaft.

Typical Pump Installations

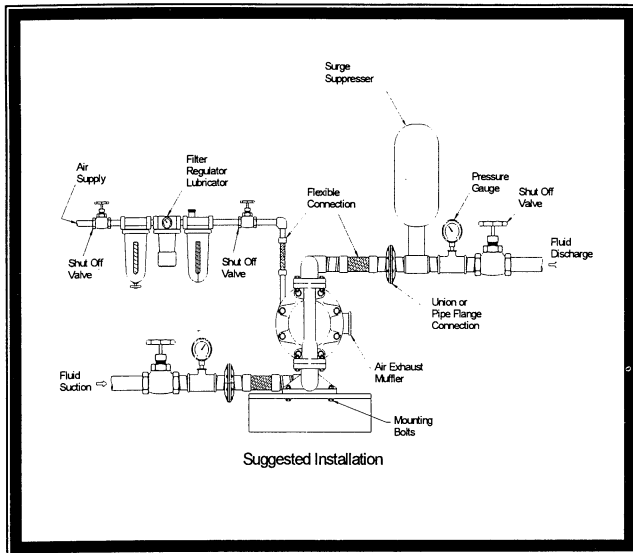

In a submerged application, the air exhaust port of the pump must be ported above the fluid line. Be certain that the fluid being pumped is compatible with the materials on both the airside and the wetted side of the pump before the pump is submerged.

◀ A typical installation showing all the components that are recommended in a system, including valves, pressure gauges, air regulators, filters, and surge suppressors.

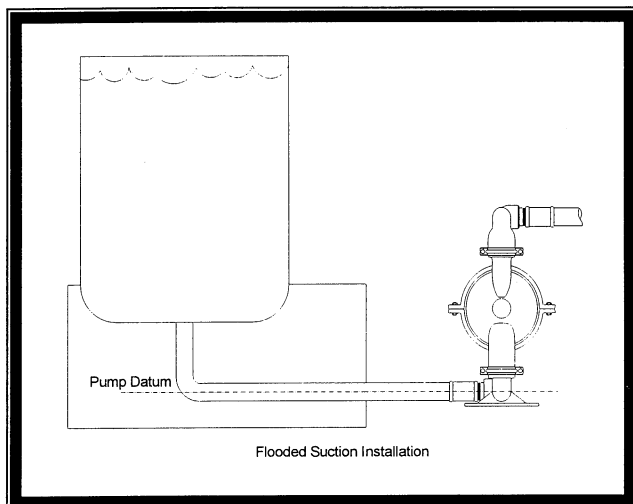
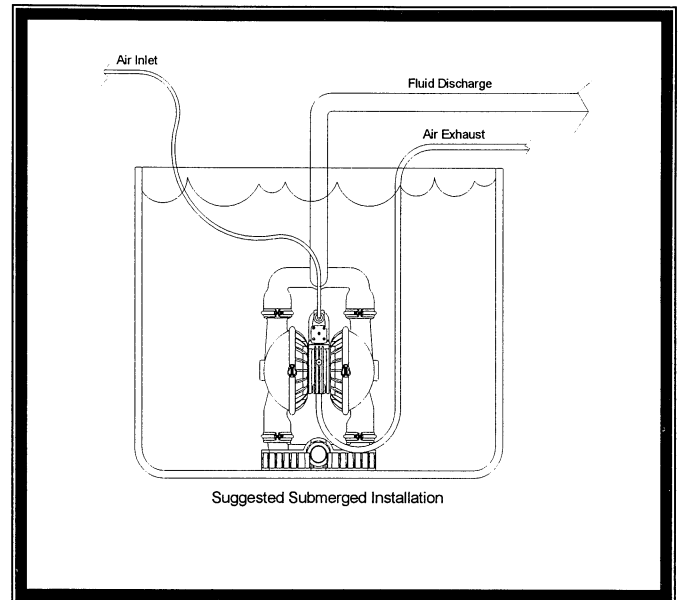

▶ In suction lift installations the pump datum is above the fluid line. **IMPORTANT-** each pump has different lift capabilities. Be sure to verify the lift capability of a particular pump before installing it into a system.

◀ A flooded suction installation has the pump datum line below the fluid level. **IMPORTANT-** in flooded suction installations the pressure at the fluid inlet of the pump should never exceed 69 kPa (10 psi).

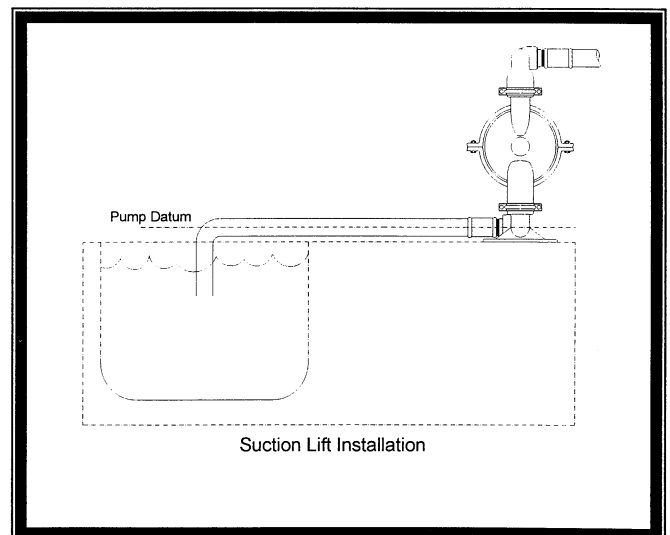

Safety Warnings and Equipment Misuse Hazards

This equipment should only be used by experienced professional mechanics. Read and observe all safety warnings and operating manuals before using or repairing this Air Operated Diaphragm Pump. (A.O.D. Pump)

This equipment may generate fluid pressures equal to the air supply pressure. **DO NOT** exceed the recommended air supply pressure of 8.5 bar (125psi)

ALWAYS wear safety glasses when using power tools to repair this equipment.

When the pumping system contains dangerous fluids wear protective gloves, glasses etc. when working on or around this equipment.

ALWAYS shut-off air supply and disconnect from pump before performing any maintenance or repair.

DO NOT put your face or body near the pump air exhaust while the pump is operating.

Bleed all pressure from discharge and suction lines before disconnecting the fluid suction or fluid discharge lines from the pump.

DO NOT operate a pump that is leaking, damaged, corroded or otherwise unable to contain the internal fluid pressure.

ALWAYS make sure safety shut-off valves, regulators, pressure relief valves, gauges etc. are working properly before starting the pump.

DO NOT pump incompatible fluids through the pump. Consult your distributor or the factory for fluid compatibility information.

Versa-Matic® pumps are designed to operate on compressed air. Other compressed gases have not been tested and may be unsafe to use in A.O.D. pumps.

Before starting a pump make certain the discharge point of the piping system is clear and safe and all persons have been warned to stand clear.

General Safety

Any misuse of this equipment such as over pressurization, modifying parts, pumping incompatible chemicals and fluids, using worn or damaged parts or using gases other than compressed air to power the pump is not recommended. Any of these circumstances could result in splashing or spraying into the eyes, skin or possible serious bodily injury, fire, explosion or property damage.

Over Pressurization

Never exceed the operating pressure recommended for the model pump being used.

Installation

Never allow the piping system to be supported by the pump manifolds or valve housing. The pump is not designed to support any structural weight, and failure may result. The use of flexible piping connections is highly recommended.

Installation Hazards

Do not submerge the pump in liquids that are incompatible with the wetted or non-wetted parts of the pump. If installing in a submerged location extend the air exhaust port above the liquid surface with a suitable pipe or hose. Route exhaust line to a safe location away from people and install an air exhaust muffler.

Pump Diaphragm Failure

A.O.D. pumps utilize an elastomeric membrane to separate the pumping fluids from the air supply. When this membrane fails pumping fluid may be expelled from the air exhaust port. Always pipe the air exhaust to a safe location or container if dangerous or volatile liquids are being pumped.

Noise

Wear proper ear protection when working or standing near A.O.D. pumps. It is recommended that an air exhaust muffler be used on this equipment at all times.

Fire or Explosion Hazard

Static electricity can be created by the flow of fluid through the pump or by the reciprocating action of A.O.D. pumps. If the pump is not properly grounded sparking may occur which can potentially ignite fumes or vapor and cause an explosion.

If you experience static sparking, or even a slight shock when using the pump, do not continue to operate the pump until properly grounded.

Proper Grounding

1. To ground plastic pumps connect a ground wire to **ALL** metallic components.
2. To ground metallic pumps, connect a ground wire to any accessible point of attachment.

Sound Level Rating

The Versa-Matic E4 Bolted pump when equipped with a factory installed air exhaust muffler will generate a sound level of **78 dB(A)**.

Temperature Limitations

Temperature limitations are based on mechanical stress only. Certain chemicals reduce the maximum safe operating temperatures of A.O.D. pumps.

Polypropylene: 0°C (32°F) to 79°C (175°F)
PVDF (Kynar): -12°C (10°F) to 107°C (225°F)

Metallic pumps can operate above 100°C (212°F). If operating temperature is above 82°C (180°F) consult your dealer or Material compatibility guide.

Versa-Matic Pump Company

Model E4, Elima-Matic Bolted Series (revised 2/08)

Item	Description	Qty	Pump Model Number			
			E4P	E4K	E4S	E4H
1	Elima-Matic Center Block	1	P31-401ASY			
2	E4 Valve Assembly (items 3 thru 10)	1	P31-200			
3	E4 Valve Body	1	P31-201 (Not sold separately)			
4	Spool	1	P50-104			
4a	Glyd-Ring Assembly	3	P50-104C			
5	Gasket, End Cap	2	P50-110			
6	Gasket, Valve	1	P31-202			
7	End Cap	2	P50-300			
8	Cap Screw	14	S1001			
9	Stop Nut	2	P24-108			
10	Retainer, Pilot Shaft	2	P50-109			
11	Space, Pilot Shaft	2	P50-119			
12	O-Ring, Pilot Valve	6	P24-107			
13	Ring, Pilot Valve	5	P24-106			
14	Pilot Shaft	1	P50-112			
15	Main Shaft	1	P31-103 (Rubber and PTFE IP fitted) / P31-102 (PTFE TF and TX fitted)			
16	Bushing O-Ring	2	P24-403			
17	Air Chamber Gasket	2	P31-109			
18	Bushing	1	P31-402			
19*	Shaft Stud	2	V161F (not required with Teflon)		N/A	
20	Inner Diaphragm Plate (Rubber & XL Fitted)	2	E414		V161C	
20A*	Inner Diaphragm Plate (PTFE Fitted only)	2	V161TI***			
21	Outer Diaphragm Plate	2	PE413	KE413	SVB161	HVB161
21A*	Outer Diaphragm Plate (PTFE Fitted)	2	PE413TO***	KE413TO***	SVB161TO***	HVB161TO***
22	Diaphragm (See below for material selection)	2	V163xx			
22A	Back-Up Diaphragm	2	V163TFB (Hytrel) or V163TFB-1 (Neoprene)			
23	Air Chamber	2	E401			
24	Air Chamber Bolt	8	P31-404			
25	Valve Ball	4	V171xx (see list below)			
26	Valve Seat	4	E408xx (see list below)		V170xx (see list below)	
27	Valve Seat O-Ring (see below**)	8	E412TES		V170T	
28	Water Chamber	2	PE404	KE404	E404S	E404H
29	Water Chamber Bolts	20	SV189D		SV185A	
30	Flat Washers	32	SV189C			
31	Water Chamber Nuts	32	N/A		SV185B	
32	Manifold Tee	2	PE411	KE411	N/A	
33	Inlet Manifold Elbow	2	PE409F	KE409F	N/A	
33A	Inlet Manifold	1	N/A		E467S	E467H
34	Discharge Manifold Elbow	2	PE409	KE409	N/A	
34A	Discharge Manifold	1	N/A		E466S	E466H
35	Manifold Tee O-Ring	4	E413xx (see list below)		N/A	
36	Manifold Bolts	12	SV189D			
37	Detent Pins	8	E417			
38	Air Exhaust Muffler	1	VTM-6			

Diaphragm Part Numbers & Material	Valve Ball Part Numbers & Material	Valve Seat Part Numbers & Material	Manifold Tee O-Ring Part Numbers and Materials
V163N, Neoprene V163BN, Buna-N V163ND, Nordel V163VT, Viton V163FG, Hytrel V163TX, One piece PTFE diaphragm (no back-up required) V163F, IP PTFE (No plates of back-up required) V163XL, TPEXL V163TF	V171N, Neoprene V171BN, Buna-N V171ND, Nordel V171VT, Viton V171SS, Stainless Steel V171TF, PTFE PTFE V171TPEFG, Hytrel V171TPEXL, XL	E408BN, Buna-N E408N, Neoprene E408D, Nordel E408VT, Viton E408FG, Hytrel E408XL, TPEXL E408P, Polypropylene E408K, Kynar PVDF ----- V170N, Neoprene V170BN, Buna-N V170VT, Viton V170ND, Nordel V170TPEFG, Hytrel V170TPEXL, Teflon XL SV170, Stainless Steel HV170, Hastelloy	E413BN, Buna-N E413N, Neoprene E413ND, Nordel E413VT, Viton E413XL, XL E413FG, FG E413TES, PTFE Encaps Silicone

* Not shown in exploded view.
** E412TES valve seat o-ring is used only with E408P & E408K valve seats.
*** V163F PTFE IP Diaphragm do not require external plates
V170T valve seat o-ring is used only with SV170 & HV170 valve seats.

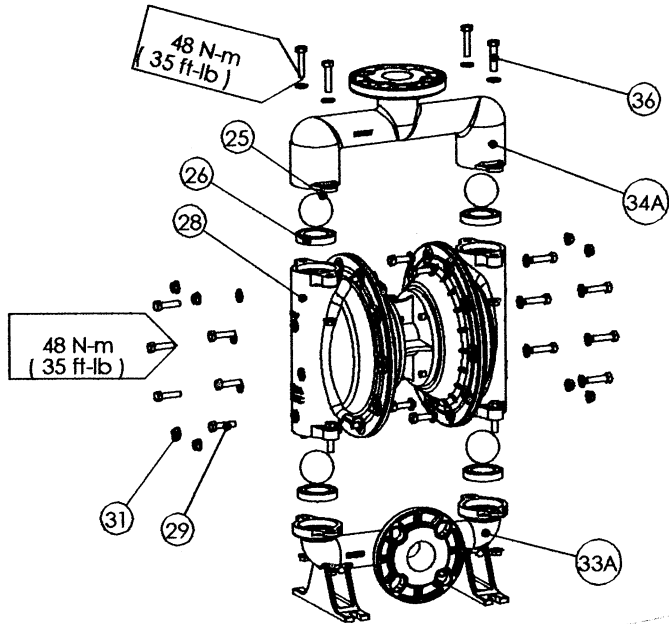

E4 METALLIC BOLTED

Refer to illustration below for center section components

Note for item #34A:

This pump is available with a vertical and horizontal discharge manifold. For a horizontal discharge manifold, please specify part number E466S.

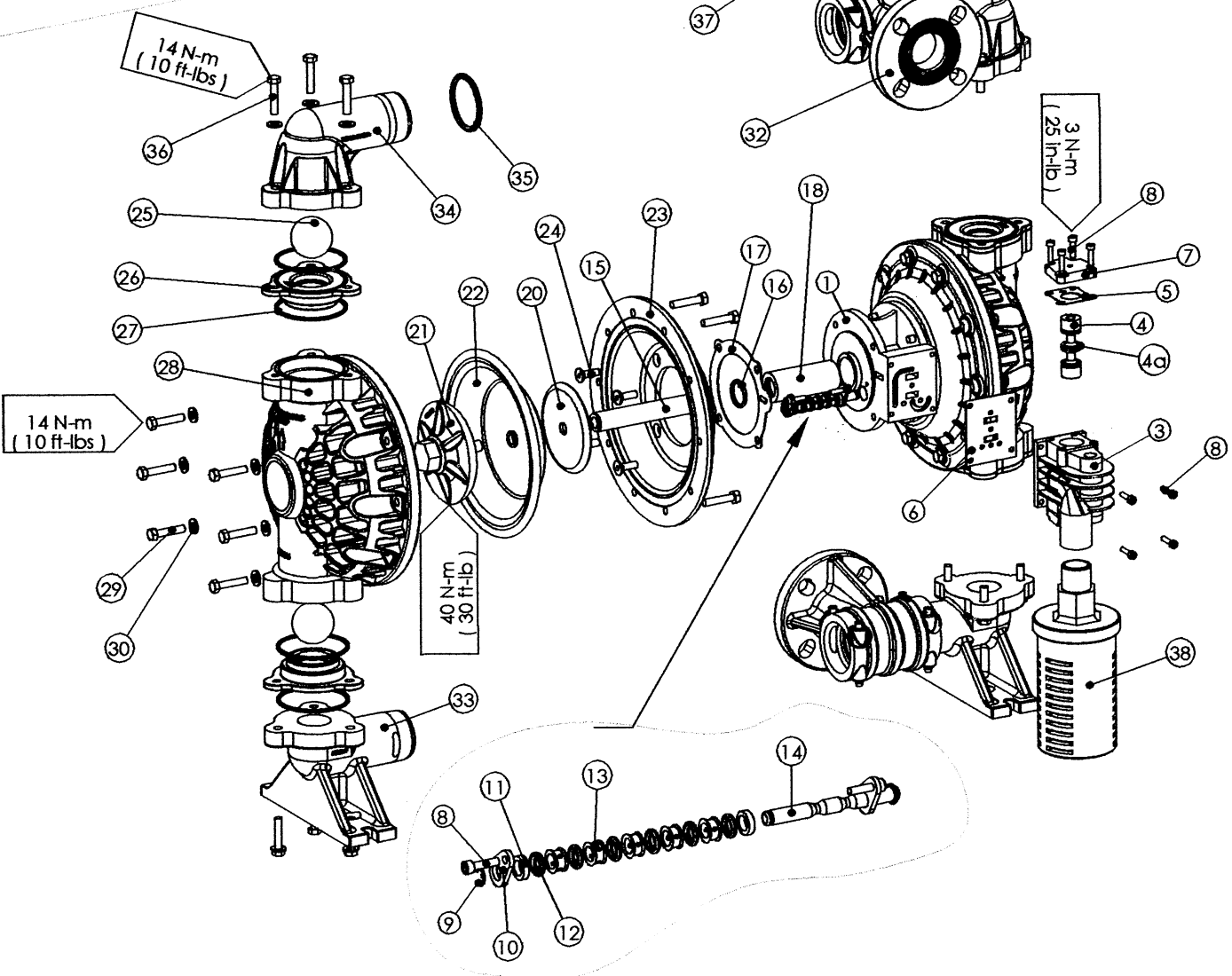

E4 PLASTIC BOLTED

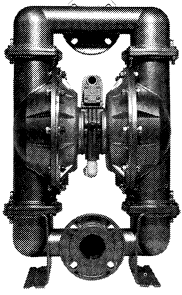

**ELIMA-MATIC®
ANTI-STALLING PUMPS**

- Virtually eliminates pump stalling caused by air valve system freeze-ups
- Anti-stalling, non-icing, lubrication-free air valve system.
- Available in 1/2", 1", 1 1/4", 2" and 3" sizes
- Wide selection of materials of construction—including 1/2", 1" and 2" plastic models

**PLASTIC PUMPS FOR SOLVENTS
AND CHEMICALS**

- Exceptional corrosion resistance
- Wide selection of materials of construction for wetted and non-wetted parts
- Leak free bolted construction
- Also available in 1/2", 1", 1 1/2" and 2" with the Elima-Matic anti-stalling air valve system

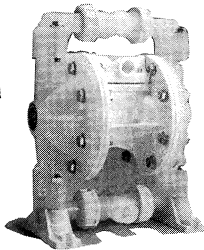

Elima-Matic 2:1 High Pressure Pump

- Cast in 150lbs ANSI/DIN flanges
- Constructed of 316 stainless steel
- Can create discharge pressure over 200 psi
- Leak-Free bolted design

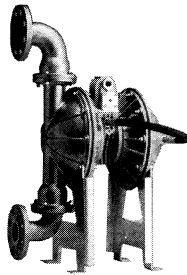

**FOOD AND SANITARY PUMPS
SANITARY PUMPS**

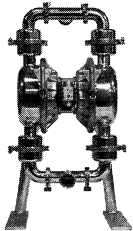

- FDA approved for use with milk and milk products
- Constructed of 316 stainless steel
- Surface finish of 32 micro-inch or better
- Removable ball cages
- Easy clean Tri-clamp® connections

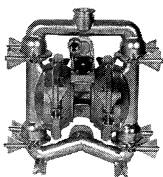

FOOD PROCESSING PUMPS

- Constructed of 316 stainless steel
- FDA approved
- Tri-clamp® connections
- Over-sized clamp wing nuts for disassembly

VERSA-MATIC PUMP

6017 Enterprise Drive
Export, PA 15632-8969
(724) 327-7867 • Fax: (724) 327-4300

www.versamatic.com

** Life cycle may vary according to extreme start-up conditions, chemicals and abrasive fluids. To prolong diaphragm life, Versa-Matic recommends a gradual increase in air supply on pump start-up.*

Elima-Matic®, Versa-Dome®, Versa-Matic® and VR ' are registered trademarks or trademarks of Versa-Matic Tool, Inc. Some Versa-Matic Tool, Inc. products are subject to patent pending applications and issued patents, Elima-Matic U.S. Patent No. 5,326,234. Hytrel®, Nordel®, Teflon® and Viton® are registered trademarks of DuPont. Tri-Clamp® is a registered Trademark of the Tri-Clamp, Inc. Wilden® is a registered Trademark of Wilden Pump and Engineering Co.

VERSA-DOME® DIAPHRAGMS

- The simple, smooth design eliminates complex angles allowing for 3 to 4 times the flex life of standard diaphragms.
- So flexible they can be installed and removed without the use of pry bars
- Has lower start up pressure than standard diaphragm.
- Available Neoprene, Buna-N, Hytrel, Nordel®, Viton® and XL.
- For use in Versa-Matic and Wilden 1/2", 2", 3" pumps.

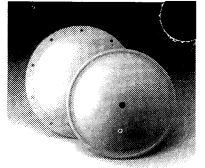

VERSA-TUFF TEFLON DIAPHRAGMS

- Single piece diaphragm combining the chemical resistance of Teflon with the flex life of rubber.*
- Three times the burst strength of ordinary Teflon overlays
- More flexible and 100% bonded to the reinforced rubber backing
- Diaphragms can be placed into Wilden® M4 and M8 pumps

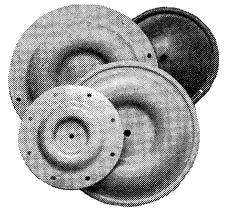

**GENUINE VERSA-MATIC REPLACEMENT
PARTS AND RETRO FIT CENTER SECTIONS**

- Upgrade V-series and Wilden® M4, M8, and M15 pumps with an Elima-Matic retro fit center section
- For complete repair of Versa-Matic pumps and Wilden® M4, M8 and M15 metallic pumps
- Cost-saving elastomer kits for any Versa-Matic pump or Wilden® M1, M2, M4, M8 and M15 pumps
- Diaphragm and elastomer repair kits available in Buna-N, Neoprene, Nordel®, Teflon®, Viton®, Thermo Plastics Hytrel®, and XL

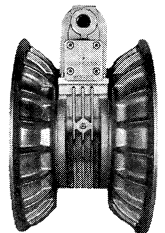

Your local authorized distributor:

